

INSTRUCTION SHEET

End Feeds - EFR | EFL | EF2

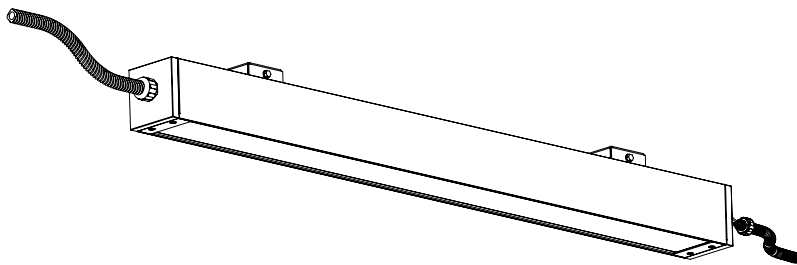

BRACKET MOUNTING CENTERS

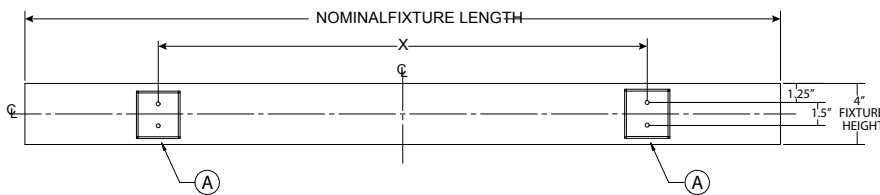

NOMINAL FIXTURE LENGTH	X
2'	16"
3'	24"
4'	32"

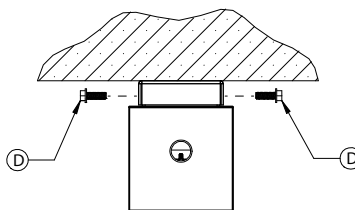
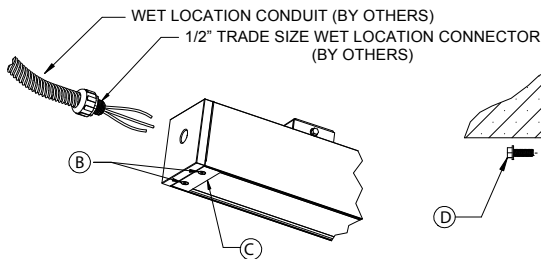
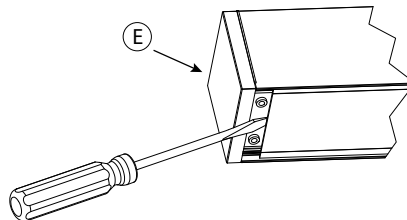

FEED TYPES

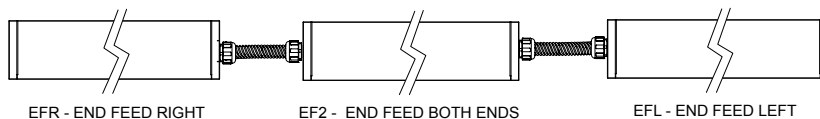

Mounting

1. Install ceiling brackets (A) as shown using 1/4" bolts (by others) suitable for intended surface.

2. Loosen captive screws (B) and remove endplates (C) from both ends.

4. Remove reflector/liner.

5. Mount fixture on ceiling brackets (A) and install supplied screws (D).

6. Connect 1/2" flex conduit to fixture. *Note: for wet locations flex conduit must be liquid tight and pipe thread sealant or teflon tape must be used on threads.

7. Make wire connections inside fixture.

8. Reinstall reflector/ liner

9. Reinstall lens. Note: firmly press along entire length of lens to ensure a good seal.

10. Reinstall both endplates (C).

note: To remove lens, lift from end using a flat blade screw driver(E) to pry loose. Note: take care not to damage lens or gasket.

Continuous run, provide for 1/8" between fixtures.

Note: To be installed by a qualified electrician per N.E.C. and all local codes.

820-00030
V-0520

INSTRUCTION SHEET

JBE - J-box Extender

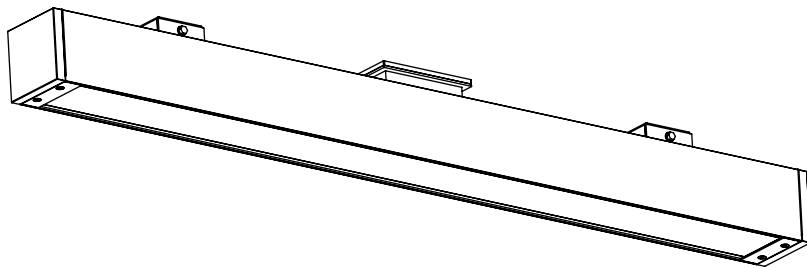

BRACKET MOUNTING CENTERS

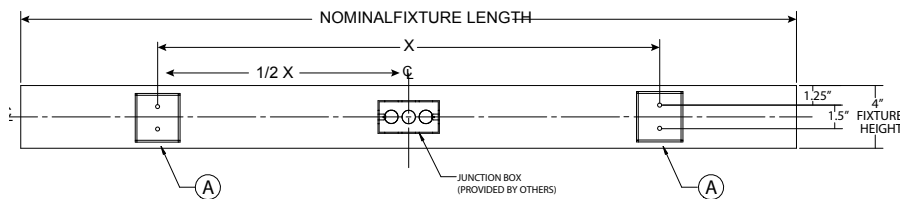

NOMINAL FIXTURE LENGTH	X
2'	16"
3'	24"
4'	32"

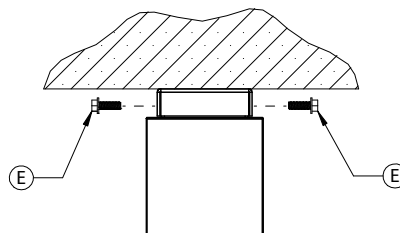
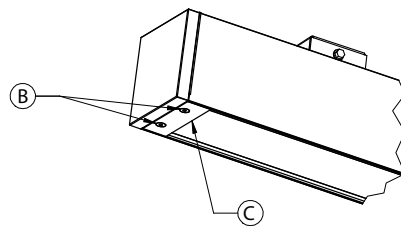
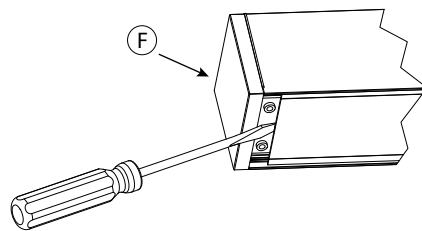
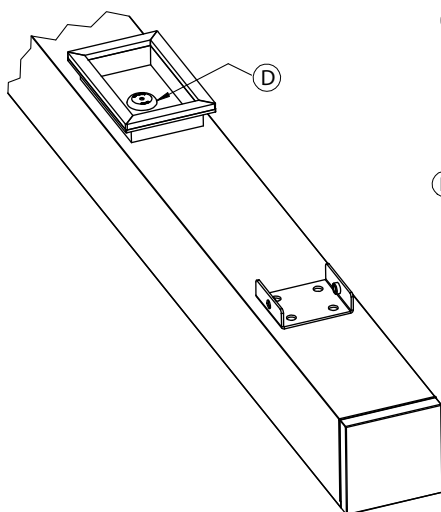

Mounting

1. Install a recessed 2" x 4" single gang junction box as shown.
2. Install ceiling brackets (A) as shown using 1/4" bolts (by others) suitable for intended surface.
3. Loosen captive screws (B) and remove end plates (C) from both ends.
4. Remove reflector/liner.
5. Pierce a small hole in the center of rubber plug (D) using a piece of solid core wire. Push wires from junction box through hole into fixture.
6. Mount fixture on ceiling brackets (A) and install supplied screws (E).
7. Make wire connections inside fixture.
8. Reinstall reflector/liner.
9. Reinstall lens. Note: firmly press along entire length of lens to ensure a good seal.
10. Reinstall both end plates (C).

note: To remove lens, lift from end using a flat blade screw driver (E) to pry loose. *Note:* take care not to damage lens or gasket.

Continuous run, provide for 1/8" between fixtures.

Note: To be installed by a qualified electrician per N.E.C. and all local codes.

820-00034
V-0520

INSTRUCTION SHEET

STND, EF, and JBE

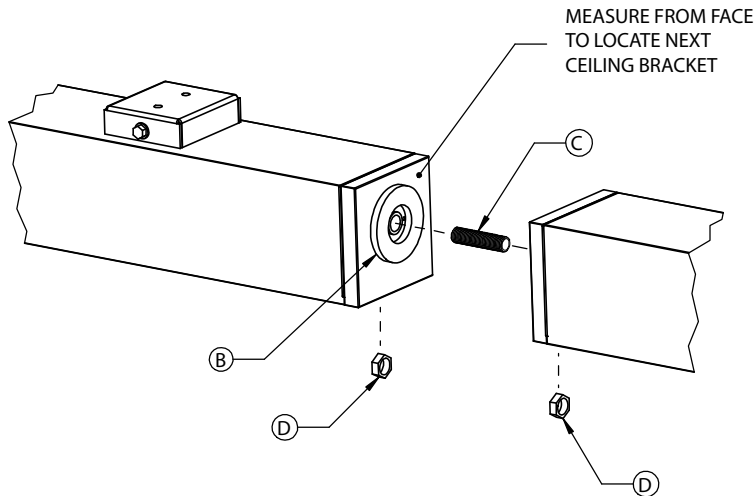

LED FIXTURE	X	Y
2'	16"	9 1/16"
3'	24"	9 1/16"
4'	32"	9 1/16"

Mounting

1. Mark 2 chalk lines as shown. Lengths should be as long as the entire continuous run length.
2. Install first fixture using accompanying installation instructions. Note: first fixture will have main power feed.
3. Measure from face of end cap to locate ceiling brackets (A) and install as shown.
4. Peel and stick gasket (B) to first fixture as shown.
5. Mount second fixture on ceiling brackets (A).
6. Install coupling (c) between first and second fixture and secure with locknuts (D).
7. Pull wire (by others) thru coupling and make connections.
8. Install additional fixtures as required.

note: To remove lens, lift from end using a flat blade screw driver (E) to pry loose. *Note:* take care not to damage lens or gasket.

Continuous run, provide for 1/8" between fixtures.

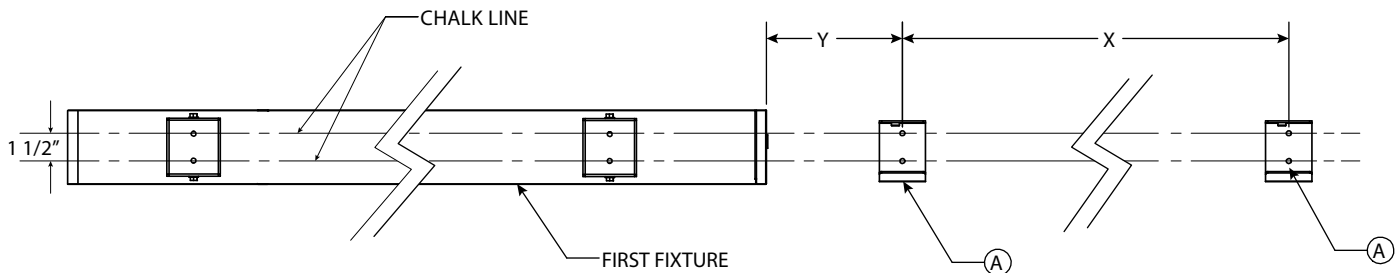

Note: To be installed by a qualified electrician per N.E.C. and all local codes.

820-00118
V-0520