

JAKE LED

4.00" Wall Graze
T-Grid

Recessed Linear LED Fixture



JAKE LED Wall Graze is a recessed linear luminaire comprised of various LED light source options that delivers high performing even illumination that reveals and accentuates texture with shadowing into the desired area. JAKE LED Wall Graze can be installed in gypsum ceilings or walls with either a 3/4" Trim (TR) or Trimless (TL) mud-over flange. T-grid models for drop ceilings are also available.

JAKE LED Light Outputs and dimmable driver components, when combined together, provide optimal LED lighting system capabilities.

Available in nominal lengths from 2' - 8' as well as continuous run.



Made in the USA



UL and c-UL listed for dry and damp locations.



FIXTURE SPECIFICATIONS

Construction

Fixture body is constructed of heavy gauge extruded aluminum. Fixtures are available in nominal lengths of 2 - 8 feet, and continuous run lengths.

Mounting

Recessed linear fixture T-Grid ceiling installations in either a Flush Lens (FLS) or a 3" Regress Lens (REG3). Available as continuous run mount. See installation information for specific details regarding installation guidelines. Various mounting clips available for ease of installation.

Finishes

Fixture exposed edges are standard Matte White (MW). Custom powder coat finishes available - consult factory.

LED Light Output System

LED Light Outputs are available as HLO (High Lumen Output) and SLO (Standard Lumen Output) providing efficient illumination. CLO (Custom Lumen Output) allows for end user specified lumen output or tailored wattage consumption for certain models. Consult factory for details.

Dimming

Dimming is available with a variety of control protocols and options. Consult factory for availability and specifications.

Custom and Mods

We proudly specialize in manufacturing custom and modified luminaires and have the ability to modify most of our standard fixtures. Please contact factory with any inquiries.

Type: Job Name:

Recessed Linear LED Fixture

SPECIFICATION CODE

model	trim style	light Output	color temp	length	voltage	driver	option	option
Model	Trim Style²	Light Output	Color Temp	Nominal Length	Voltage	Driver	Options	
JAK-LED-WG-FLS-400 - Flush Lens	T-Grid Ceilings LT9 - 9/16" exposed lay-in	SLO - Standard Lumen Output	27 - 2700K 30 - 3000K 35 - 3500K	2⁷ - 2' 3⁷ - 3' 4⁷ - 4'	120 277 347⁴	D1 - 1% (nom) 0-10V HLA2³ - LTEA2W Lutron	Finishes² CUP - Custom powder coat	
JAK-LED-WG-REG3-400 - 3" Regress Lens	LT15 - 15/16" exposed lay-in TT9 - 9/16" Tegular TT15 - 15/16" Tegular ITA - Interlude® ST9 - Slot Grid	HLO - High Lumen Output CLO⁴ - Custom Lumen Output CLO Calculator	40 - 4000K	6⁷ - 6' 8⁷ - 8'	CR⁷ - Continuous Run WW⁶ - Wall-to-Wall 1WL⁸ - 1 Wall Left 1WR⁸ - 1 Wall Right MTR⁹ - Miter	H-Lume 1%, 2 wire HL - LDE1 Lutron Hi-Lume 1% EcoSystem DALI - DALI	CP⁵ - Chicago Plenum	

Dimensions

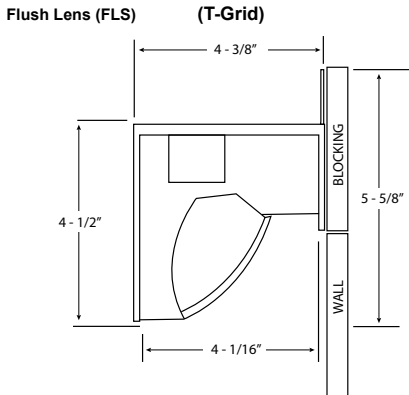

3" Regress Lens (REG3)

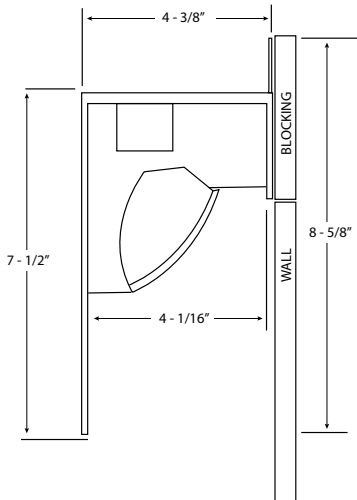

NOTES

- 1 specify lengths in nominal feet
- 2 fixture exposed edges are standard Matte White, see [option sheet](#) for custom finishes
- 3 see [instruction sheet](#) for mounting info
- 3 120V only
- 4 available for D1, D10 drivers only
- 5 compliant with CCEA Chicago Plenum code requirements
- 6 exact measurements between wall surfaces required
- 7 fixture is positioned off the wall and includes all trim/flange pieces
- 8 elevation view facing fixture side of wall (1) wall with (1) trim/flange piece
- 9 see [Miter worksheet](#) for details

Fixture Performance

JAK-LED-WG-FLS-400 (4000K)

SLO - 114.3 lm/watt delivered @ 4.4 w/ft fixture input watts, 503 lm/ft.
HLO - 107.4 lm/watt delivered @ 9 w/ft fixture input watts, 967 lm/ft.
CLO - refer to [CLO Calculator](#)
400 LED [supplement info](#)

JAK-LED-WG-REG3-400 (4000K)

SLO - 114.3 lm/watt delivered @ 4.4 w/ft fixture input watts, 503 lm/ft.
HLO - 107.4 lm/watt delivered @ 9 w/ft fixture input watts, 967 lm/ft.
CLO - refer to [CLO Calculator](#)
400 LED [supplement info](#)

Photometrics

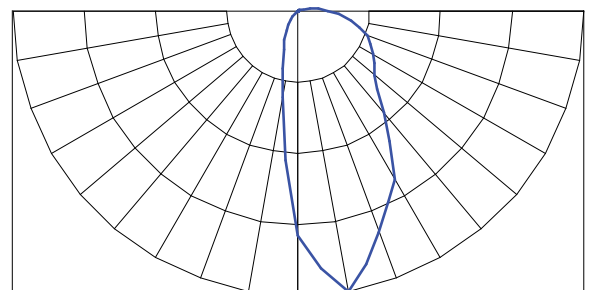

V-0519

Type:

Job Name:

Recessed Linear LED Fixture

T-GRID TRIM STYLES

ST9 - 9/16 SLOT GRID

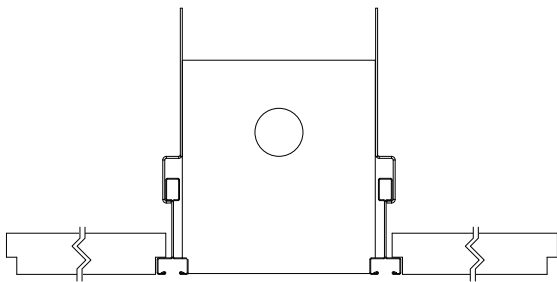

ITA - Interlude

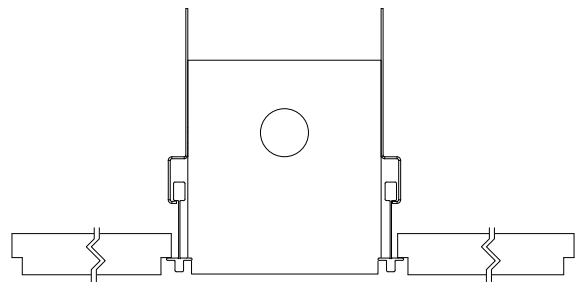

LT9 - 9/16 LAY-IN

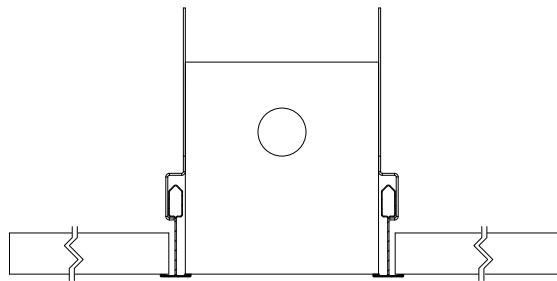

TT9 - 9/16 TEGULAR

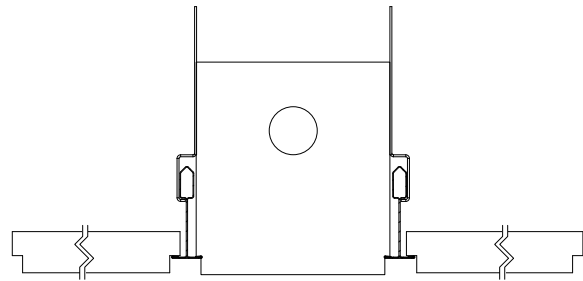

LT15 - 15/16 LAY-IN

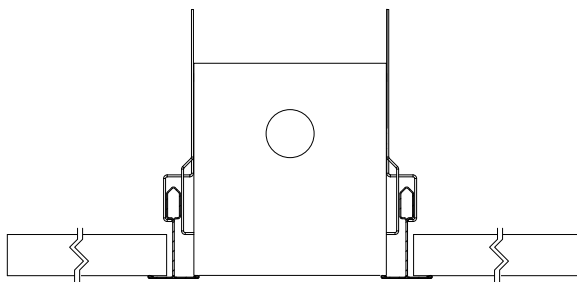

TT15 - 15/16 TEGULAR

