



JAKE LED Wall Wash is a recessed linear luminaire comprised of various LED light source options that delivers high performing smooth illumination to the intended area and creating visual interest to the space. JAKE LED Wall Wash can be installed in gypsum ceilings or walls with either a 3/4" Trim (TR) or Trimless (TL) mud-over flange. T-grid models for drop ceilings are also available.

JAKE LED Light Outputs and dimmable driver components, when combined together, provide optimal LED lighting system capabilities. Optional Kicker Reflector (KR) delivers light to upper corners of wall/ceiling transitions to minimize shadowing.

Available in nominal lengths from 2' - 8' as well as continuous run.



Made in the USA



UL and c-UL listed for dry and damp locations.



Chicago Plenum



IC rated

## FIXTURE SPECIFICATIONS

### Construction

Fixture body is constructed of heavy gauge extruded aluminum. Fixtures are available in nominal lengths of 2 - 8 feet, and continuous run lengths.

### Mounting

Recessed linear fixture for drywall or wood installations. Available as continuous run mount. See installation information for specific details regarding installation guidelines. Various mounting clips available for ease of installation.

### Finishes

Trim (TR) is standard Satin Clear (SC) anodized. Trimless (TL) is standard Mill finish. Custom powder coat finishes available - consult factory.

### LED Light Output System

LED Light Outputs are available as HLO (High Lumen Output) and SLO (Standard Lumen Output) providing efficient illumination. CLO (Custom Lumen Output) allows for end user specified lumen output or tailored wattage consumption for certain models. Consult factory for details.

### Dimming

Dimming is available with a variety of control protocols and options. Consult factory for availability and specifications.

### Custom and Mods

We proudly specialize in manufacturing custom and modified luminaires and have the ability to modify most of our standard fixtures. Please contact factory with any inquiries.

Type: Job Name:

Recessed Linear LED Fixture

**SPECIFICATION CODE**

**JAK-LED-WW-350**

model	trim style	light Output	color temp	length	voltage	driver	option	option	
Model	Trim Style <sup>2</sup>	Light Output	Color Temp	Nominal Length	Voltage	Driver	Options		
<b>JAK-LED-WW-350</b>	<b>TR</b> - 3/4" flanged trim	<b>SLO</b> - Standard Lumen Output	<b>27</b> - 2700K / 80CRI <b>30</b> - 3000K / 80 CRI <b>309</b> - 3000K / 90 CRI	<b>2</b> - 2' <b>3</b> - 3' <b>4</b> - 4'	<b>120</b> <b>277</b> <b>347<sup>5</sup></b>	<b>D1</b> - 1% (nom) 0-10V <b>HZA2<sup>4</sup></b> - LTA2W Lutron Hi-Lume 1%, 2 wire	<b>FB</b> - Flat Black <b>MW</b> - Matte White <b>CUP</b> - Custom powder coat  <b>Mounting Options<sup>3</sup></b> <b>OHMB</b> - Overhead Mounting Bracket <b>BF</b> - Backer Flange <b>HB</b> - Hanger Bracket  <b>CP<sup>6</sup></b> - Chicago Plenum  <b>KR</b> - Kicker Reflector		
	<b>TL</b> - Trimless Mud-over flange	<b>HLO</b> - High Lumen Output <b>CLO<sup>5</sup></b> - Custom Lumen Output	<b>35</b> - 3500K / 80 CRI <b>359</b> - 3500K / 90 CRI <b>40</b> - 4000K / 80 CRI <b>409</b> - 4000K / 90 CRI	<b>6</b> - 6' <b>8</b> - 8'	<b>HL</b> - LDE1 Lutron Hi-Lume 1% EcoSystem <b>DALI</b> - DALI				

[CLO Calculator](#)

**Dimensions**

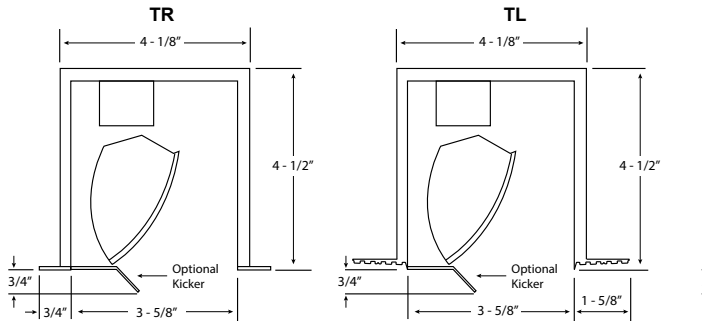

**NOTES**

- 1 specify lengths in nominal feet
- 2 TR standard is Satin Clear, TL standard is Mill Finish. See [option sheet](#) for custom finishes
- 3 see [instruction sheet](#) for mounting info
- 4 120V only
- 5 available for D1, D10 drivers only
- 6 compliant with CCEA Chicago Plenum code requirements

**Fixture Performance**

**JAK-LED-WW-350 (4000K)**

**SLO** - 79.1 lm/watt delivered @ 4.4 w/ft fixture input watts, 348 lm/ft.  
**HLO** - 74.4 lm/watt delivered @ 9 w/ft fixture input watts, 670 lm/ft.  
**CLO** - refer to [CLO Calculator](#)  
350 LED [supplement info](#)

Type:

Job Name:

Recessed Linear LED Fixture

**Photometrics**

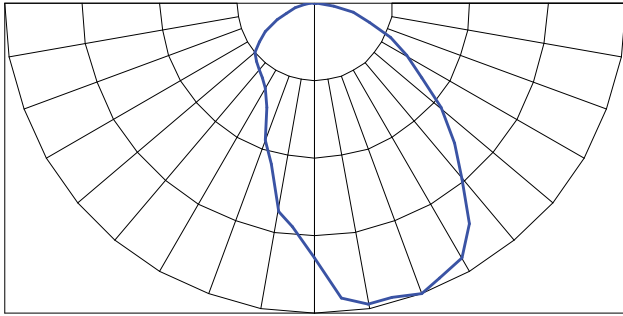

With Optional Kicker (KIC)

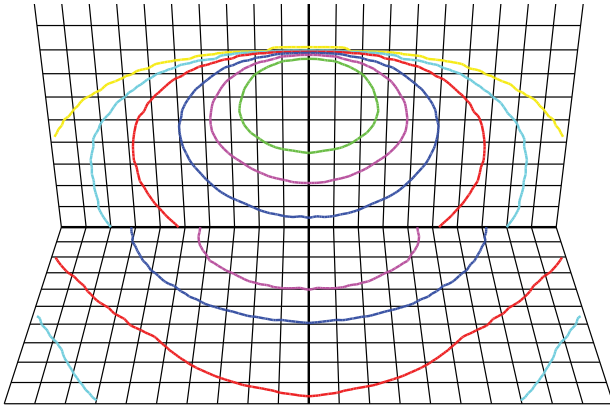
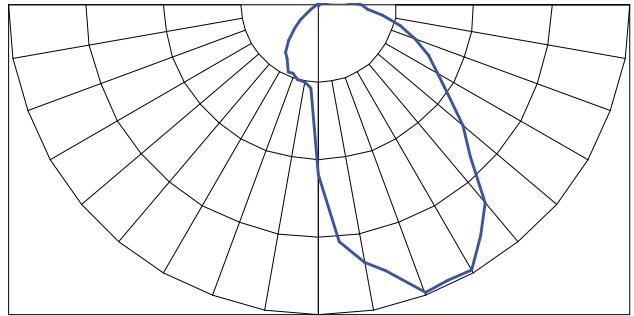

Fixture is mounted at 8' height and 2.0' from the wall

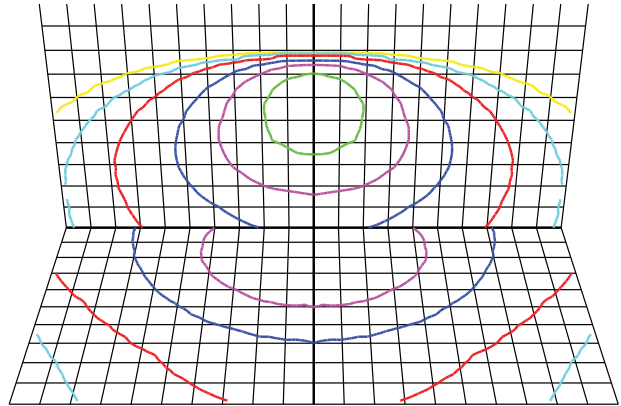

Fixture is mounted at 8' height and 3.0' from the wall

With Optional Kicker (KIC)

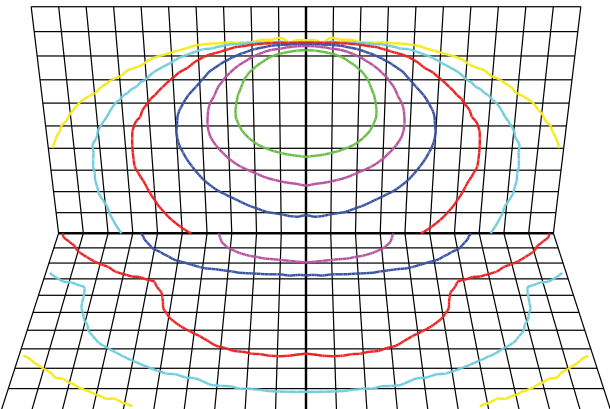

Fixture is mounted at 8' height and 2.0' from the wall

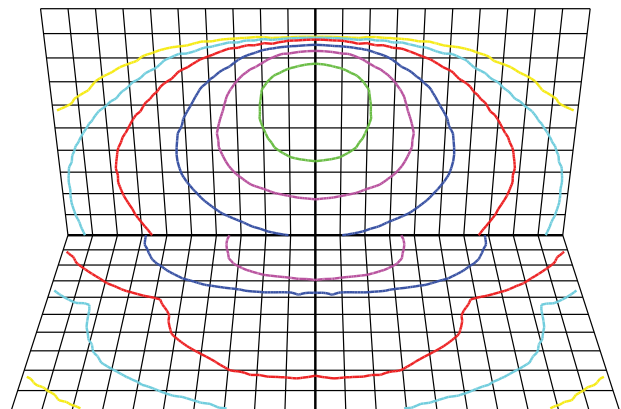

Fixture is mounted at 8' height and 3.0' from the wall

Gridscale = 1.0 ft per increment  
Footcandle Legend

0.5 fc 1.0 fc 2.0 fc 5.0 fc 10.0 fc 20.0 fc

V-1016