

KEL-LED-125 / CSS

KELSEY LED 1.25" Square Linear (Remote Only) / Cable Suspended (CSS) & Rotational Cable Suspended (CSS-R)

TYPE:

JOB NAME:



DIMENSIONS:

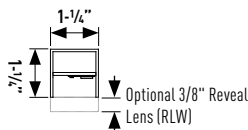

Light Output	Nominal Delivered Lumens / Wattage			
	Direct		Indirect	
FW Lens: 3500K/80CRI				
SLO	283 lm/ft	2.9 W/ft	283 lm/ft	2.9 W/ft
HLO	565 lm/ft	5.9 W/ft	565 lm/ft	5.9 W/ft

Wattage includes driver and LED Module consumption. Delivered lumen output will vary depending on CCT, CRI, and Optic selection.

CONSTRUCTION

Heavy gauge square extruded aluminum housing. 1/4" thick precision-machined aluminum end-caps. Extruded acrylic lenses specifically engineered to maximize the performance and transmission from a variety of light sources.

LED LIGHT OUTPUT SYSTEM

- HLO (High Lumen Output) & SLO (Standard Lumen Output) providing efficient illumination.
- CLO (Custom Lumen Output) User specified lumen output & wattage. Consult factory for details.
- Rated life of L70 > 60,000 hours based on LED testing per LM-80-08 and projected values using IESNA TM21-11

DIMMING

- 0-10V Dimming 1%
- elidoLED 0-10V 0.1% or 1%
- Lutron® LTEA2W Hi-Lume 2-Wire 1%
- Lutron® LDE1 Hi-Lume EcoSystem 1%
- DALI Dimming 1%

LENS

- Impact resistant co-extruded lens with highly reflective internal cavity
- (HE) High Efficiency lens provides optimal performance with even and continuous diffusion
- (FBLSS) Flat Blade Louver Semi-Specular with diffusing layer

FIXTURE LENGTH

- Nominal Lengths: 2', 3', 4', 6', and 8'
- Continuous run & mitered angles available. Consult factory for lead times.

MOUNTING

- (CSS) Cable Suspension System field adjustable 1/16" aircraft cable or (CSS-R) Cable Suspension Rotational System
- Standard matte white, flat black, or matte silver 5" canopy with 36" field-adjustable aircraft cable. Consult factory for longer lengths.
- Power cord is color matched to canopy finish. Consult factory for additional canopy options and cable lengths.

REMOTE DRIVER BOX

Remote box included. Above ceiling access required for servicing. Formed aluminum construction with knock-outs. Consult factory for maximum recommended mounting distance.

FINISHES

Available finishes includes powder coated Matte White (MW), Flat Black (FB), and Matte Aluminum (MA). Consult factory for custom powder coat finishes.

LISTING / WARRANTY

- 5-Year Limited Warranty
- UL Listed to US and Canadian standards



ORDERING CODE: (Example: KEL-LED-125-SLO-30-2-MW-FW-120-D1-CSS-DR-36MW)

1: Model	2: Light Output	3: CCT / CRI	4: Nominal Length	5: Finish	6: Lens
KEL-LED-125 (1.25")	-SLO (Standard Lumen Output)	-279 (2700K / 90CRI)	-2 (2ft)	-MW (Matte White, Powder Coat)	-FW (Frosted White)
	-HLO (High Lumen Output)	-30 (3000K / 80CRI)	-3 (3ft)	-FB (Flat Black, Powder Coat)	-RLW (Reveal Frosted White 3/8 Extended)
	-CLO ¹ (Custom Lumen Output)	-309 (3000K / 90CRI)	-4 (4ft)	-MA (Matte Aluminum, Powder Coat)	
		-35 (3500K / 80CRI)	-6 (6ft)	-CUP ⁴ (Custom Powder Coat)	
		-359 (3500K / 90CRI)	-8 (8ft)		
		-40 (4000K / 80CRI)	-CR ² (Continuous Run)		
	-409 (4000K / 90CRI)	-MTR-R ³ (Miter Run)			

7: Voltage	8: Driver	9: CSS Mounting Options	10: Canopy/Cable Length	11: Options
-120 (120V)	-D1 (0-10V Dimming 1%)	-CSS-DR (CSS Direct)	-36MW (5" Round Matte White Canopy, 36" Aircraft Cable)	EM ⁴ (Emergency Battery Pack)
-277 (277V)	-ED10V1 (elidoLED 0-10V 1%)	-CSS-IN (CSS Indirect)	-36FB (5" Round Flat Black Canopy, 36" Aircraft Cable)	
-347 ¹ (347V)	-ED10V01 (elidoLED 0-10V 0.1%)	-CSS-R (CSS-R w/ 1.25" Knuckle)	-36MS (5" Round Matte Silver Canopy, 36" Aircraft Cable)	
	-HLA2 ⁵ (LTEA2W Lutron Hi-Lume 2-Wire 1%)		-CU ⁴ (Custom Length, Consult Factory)	
	-HL (LDE1 Lutron Hi-Lume Ecosystem 1%)			
	-DALI (DALI Dimming 1%)			

Notes

- Consult factory, available with D1 options only
- Specify length in "feet"
- See [miter worksheet](#) for specification (detailed drawing required)
- Consult factory
- Lutron HLA2, 120V only

SPECIFICATION SHEET / LM-0912.22 P-3

BIRCHWOOD LIGHTING | 3340 E La Palma Ave, Anaheim, CA 92806 | tel 714 550-7118 | fax 714 550-7151 | www.birchwoodlighting.com

For Birchwood Lighting's limited product warranty, go to www.birchwoodlighting.com. For a printed copy of the warranty, you may call 800 961-5321.

© 2022 Birchwood Lighting, Inc. All rights reserved. **Note:** This document is subject to change without notice.

BIRCHWOOD | a LEVITON[®]
lighting | company

KEL-LED-125 / CSS

KELSEY LED 1.25" Square Linear (Remote Only) / Cable Suspended (CSS) & Rotational Cable Suspended (CSS-R)

TYPE: _____

JOB NAME: _____

DIMENSIONS:

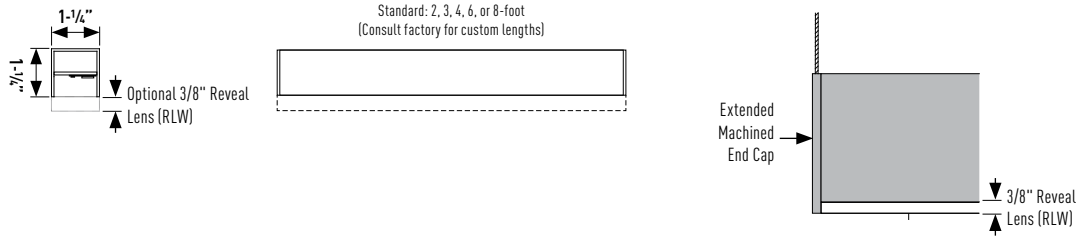

STANDARD CABLE SUSPENDED SYSTEM

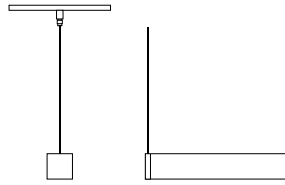

1.25" CABLE SUSPENDED ROTATIONAL SYSTEM

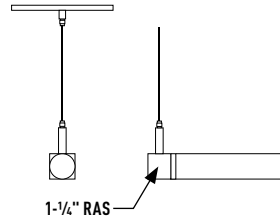

NOMINAL DELIVERED LUMEN DATA

Kelsey 125 Optic Type	SLO: Direct		SLO: Indirect		HLO: Direct		HLO: Indirect	
	Lumen Per Foot	Wattage Per Foot	Lumen Per Foot	Wattage Per Foot	Lumen Per Foot	Wattage Per Foot	Lumen Per Foot	Wattage Per Foot
Frosted White (FW)	283 lm/ft	2.9 W/ft	283 lm/ft	2.9 W/ft	565 lm/ft	5.9 W/ft	565 lm/ft	5.9 W/ft

Frosted White

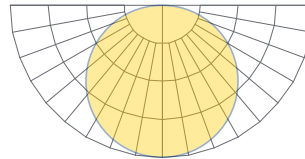

**Efficacy: up to 95lm/W
Beam: 105°**

KEL-LED-125 / CSS

KELSEY LED 1.25" Square Linear (Remote Only) / Cable Suspended (CSS) & Rotational Cable Suspended (CSS-R)

TYPE:

JOB NAME:

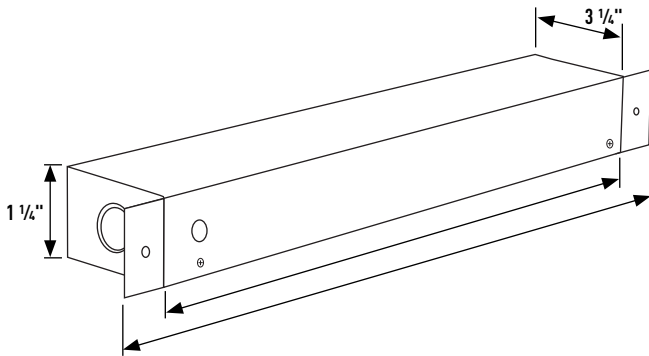

BB16A: RECESSED REMOTE DRIVER BOX

- L=16"
- Panel Cut Out= 2 1/4 x 16 1/16

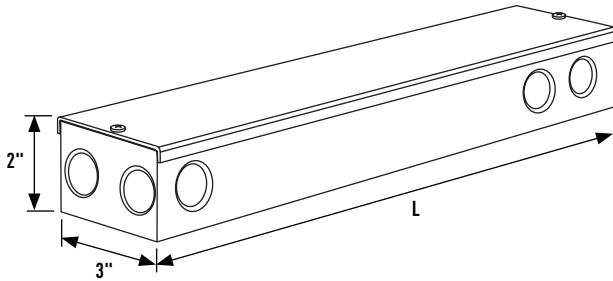

BB14B: STANDARD REMOTE DRIVER BOX

- L=16"
- Panel Cut Out= 2 1/4 x 16 1/16

BB23B: STANDARD REMOTE DRIVER BOX

- L=23"
- Panel Cut Out= 3 x 2

BB28B: RECESSED REMOTE DRIVER BOX

- L=28"
- Panel Cut Out= 3 x 2

(Surface Mount in Any Orientation)